

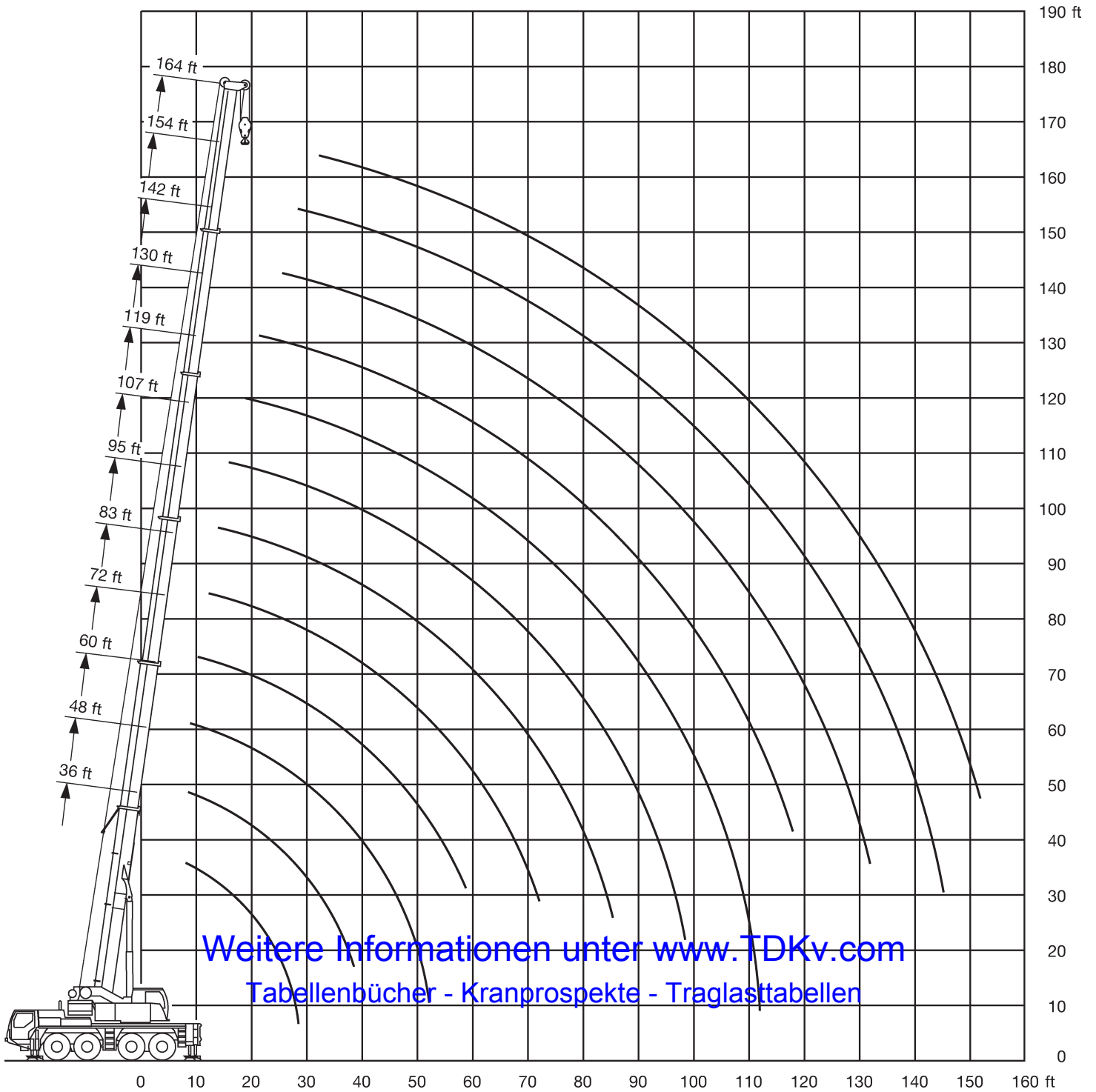

Weitere Informationen unter www.TDKv.com

Tabellenbücher - Kranprospekte - Traglasttabellen

Load Blocks	Capacity	Stops	Weight
	84.4 tons	3	992 lbs
	35.3 tons	1	606 lbs
	12.5 tons	-	309 lbs







	36*	36	48	60	72	83	95	107	119	130	142	154	164	
9		150	140	140										9
10	180	150	140	139	118									10
12	146	145	137	131	118	96								12
14	134	132	126	121	115	96	82.5							14
16	124	120	117	112	108	96	81.5	61.5						16
18	116	110	109	105	101	94	79.5	61.5	54.6					18
20	108	101	102	98	94.5	91	77.5	61.5	54.5	42.9				20
23	96	88.5	90	89	85.5	82.5	74.5	61.5	53.6	42.9				23
26	83	77.5	79	79	78	75	71.5	58.5	51.5	42.4	34			26
29	63.5	63	70	70.5	68	66.5	63	54.7	48.8	41.2	33.5	25.1		29
32			62	62.5	60.5	59	55.9	50.9	45.9	39.5	32.7	25.1	21.8	32
35			55.5	55.7	54.8	52.7	50	47	43.2	37.6	31.5	25.1	21.8	35
38			50.2	50.8	49.6	47.5	45	43	40.7	35.8	30.3	24.8	21.5	38
44				42.1	41.3	39.5	37.4	36.4	34.5	32.4	27.8	23.4	20.6	44
50				34.8	34.8	33.4	31.8	31.6	29.8	28.5	25.6	21.9	19.4	50
56					29.5	28.7	28.2	27.5	26	24.6	23.6	20.5	18.1	56
62						24.8	25.3	24	22.7	21.7	21.3	19.1	16.9	62
68						21.4	22.1	21.1	20.4	19.6	18.7	17.8	15.8	68
74							19.3	18.7	18.7	17.6	16.6	16.5	14.8	74
80							17.1	16.8	16.6	15.7	15.2	15	13.9	80
86								15.2	14.7	14.5	14.1	13.4	13	86
92								13.9	13.1	12.9	12.7	11.8	11.7	92
98								12.5	12	11.6	11.2	10.5	10.4	98
104									11.1	10.4	10	9.2	9.2	104
110									10.1	9.4	8.9	8.3	8.2	110
116										8.5	8.1	7.4	7.3	116
122											7.3	6.6	6.5	122
128											6.7	5.9	5.8	128
134												5.3	5.2	134
140												4.7	4.7	140
146													4.2	146

* over rear

Weitere Informationen unter www.TDKv.com

Tabellenbücher - Kranprospekte - Traglasttabellen





 Ft	36	48	60	72	83	95	107	119	130	142	154	164	 Ft
9	150	140	140										9
10	150	140	139	118									10
12	145	137	131	118	96								12
14	131	126	121	115	96	82.5							14
16	119	117	112	108	96	81.5	61.5						16
18	109	109	105	101	94	79.5	61.5	54.6					18
20	99.5	101	98	94	91	77.5	61.5	54.5	42.9				20
23	85.5	87	87.5	83.5	80	74.5	61.5	53.6	42.9				23
26	75	76	74.5	71	69	65	58.5	51.5	42.4	34			26
29	62.5	67	64.5	63	60.5	57	53.6	48.8	41.2	33.5	25.1		29
32		58.7	57.6	55.8	53.2	50.3	48.2	45.4	39.5	32.7	25.1	21.8	32
35		52.1	51.5	49.7	47.4	44.9	43.4	41.1	37.6	31.5	25.1	21.8	35
38		46.2	46.2	44.6	42.6	40.5	39.6	37	35.6	30.3	24.8	21.5	38
44			37.8	37	35.4	34.4	33.5	31.5	30.2	27.8	23.4	20.6	44
50			31.2	31.1	29.8	29.7	28.5	26.9	26	24.9	21.9	19.4	50
56				26.3	25.5	25.8	24.4	23.7	22.8	21.7	20.5	18.1	56
62					22	22.4	21.4	21.2	20	19.2	18.7	16.9	62
68					19	19.5	19.3	18.6	17.8	17.5	16.6	15.7	68
74						16.9	17.3	16.3	16.1	15.6	14.6	14.3	74
80						14.9	15.2	14.5	14.3	13.8	12.8	12.6	80
86							13.3	13.2	12.5	12.1	11.3	11.1	86
92							11.9	11.7	11	10.6	9.7	9.6	92
98							10.7	10.4	9.7	9.3	8.6	8.5	98
104								9.3	8.7	8.3	7.6	7.5	104
110								8.5	7.8	7.4	6.7	6.6	110
116									7.1	6.6	5.9	5.9	116
122										5.9	5.3	5.2	122
128										5.3	4.6	4.6	128
134											4	4	134
140											3.4	3.5	140
146												2.9	146

Weitere Informationen unter www.TDKv.com

Tabellenbücher - Kranprospekte - Traglasttabellen



	36	48	60	72	83	95	107	119	130	142	154	164	
9	150	140	140										9
10	150	140	139	118									10
12	143	137	131	118	96								12
14	129	126	120	111	96	82.5							14
16	114	111	104	95.5	87.5	81	61.5						16
18	99	94.5	90	83.5	77	72.5	61	54.6					18
20	84	80	77	72.5	67.5	63	59.5	53.9	42.9				20
23	67	65	63	59.6	56.1	52.8	49.9	48	42.9				23
26	55.7	54.5	52.9	50.6	47.7	46.8	44	41.1	38.2	34			26
29	46.4	46.5	45.4	43.5	41.4	40.6	38.2	36.5	34.5	32.1	25.1		29
32		40	39.2	37.6	36	35.4	33.8	32.5	31	28.5	25.1	21.8	32
35		34.8	34.2	33.7	31.6	31.2	30.5	29	28	25.9	24.5	21.8	35
38		30.4	30.3	30.3	27.9	28.4	27.5	26.3	25.2	23.8	22.5	21.3	38
44			24.2	24.7	23.4	23.5	22.5	21.7	20.5	19.6	18.3	17.9	44
50			19.5	20.2	19.7	19.5	18.7	18	17	16.2	15	14.7	50
56				16.7	16.5	16.4	15.7	15.1	14.2	13.5	12.4	12.2	56
62					13.8	13.8	13.3	12.8	12	11.3	10.3	10.1	62
68					11.5	11.6	11.3	10.9	10.1	9.6	8.6	8.5	68
74						9.8	9.5	9.2	8.6	8.1	7.2	7	74
80						8.4	8.2	7.9	7.3	6.9	6	5.8	80
86							7	6.8	6.2	5.8	4.9	4.8	86
92							6.1	5.9	5.3	4.9	4	3.9	92
98							5.4	5.1	4.5	4.1	3.2	3.1	98
104								4.4	3.8	3.4	2.6	2.5	104
110								3.7	3.1	2.8			110
116									2.5				116

Weitere Informationen unter www.TDKv.com

Tabellenbücher - Kranprospekte - Traglasttabellen

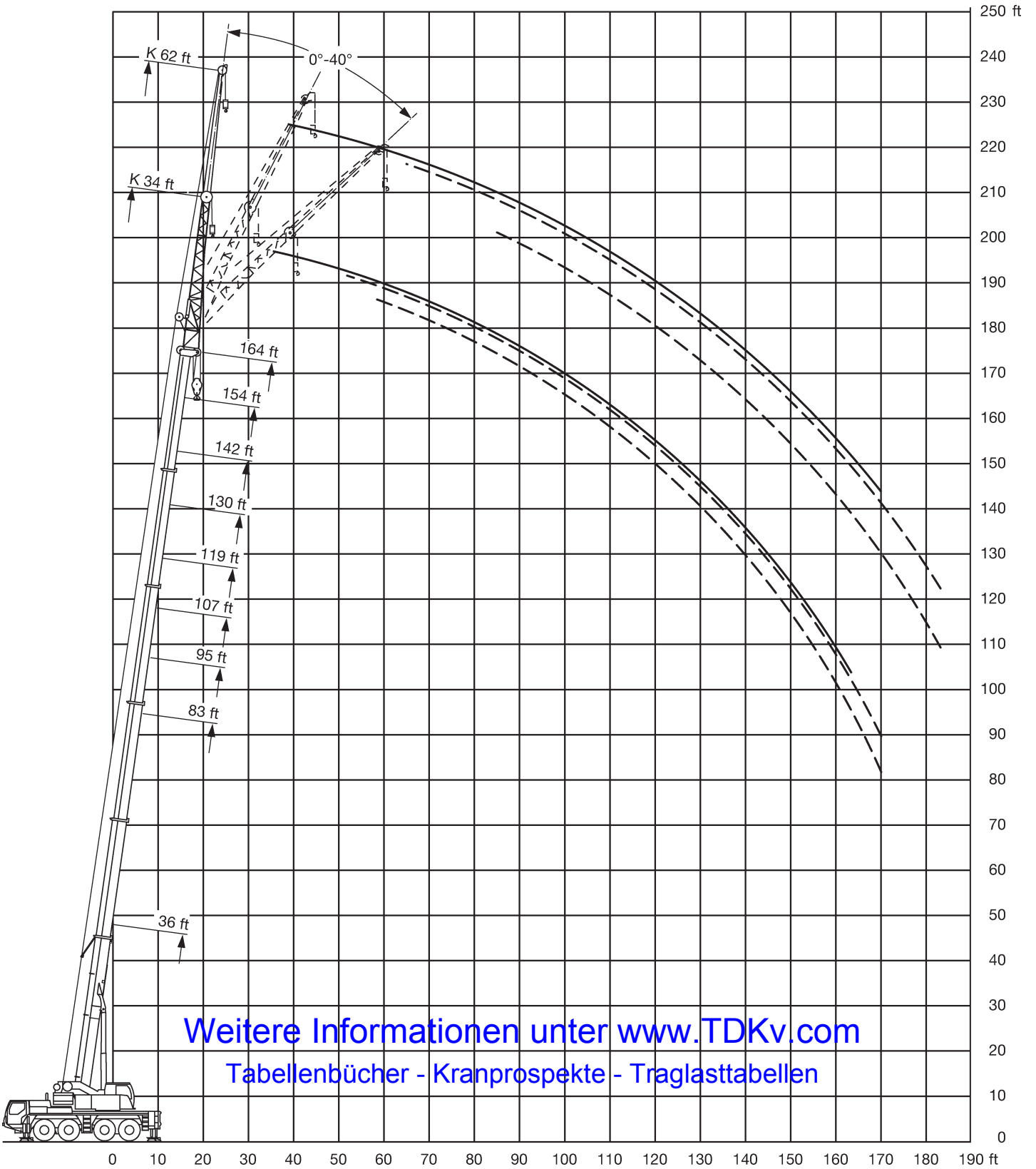

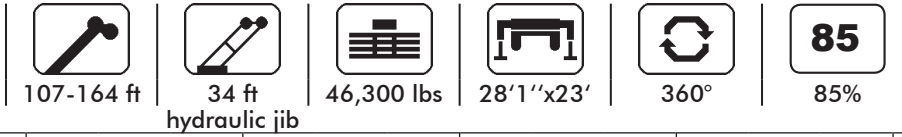

ft	107			119			130			142			154			164			ft
	0°	20°	40°	0°	20°	40°	0°	20°	40°	0°	20°	40°	0°	20°	40°	0°	20°	40°	
20	25.1																		20
23	25.1																		23
26	25.1			23.8															26
29	25.1			23.8			20.4												29
32	25.1			23.8			20.4			17									32
35	25.1	20.6		23.5			20.3			17									35
38	25.1	20.3		23.2	19.4		20.2			17			12.5			10.7			38
44	24.1	19.3	15.5	22.3	18.8	15	19.8	17.5		16.9	16		12.6			10.7			44
50	22.9	18.4	15.2	21.4	18	14.9	19.3	17.1	14.3	16.4	15.5	13.8	12.5	11.6		10.7	10.2		50
56	21.8	17.7	14.8	20.6	17.3	14.6	18.6	16.6	14.2	15.7	14.6	13.6	12.2	11.4	10.4	10.5	10	9.5	56
62	20.5	17	14.5	19.6	16.7	14.3	17.6	16.1	14	14.7	13.7	12.9	11.7	10.9	10.2	10.1	9.7	9.3	62
68	18.9	16.3	14.2	17.9	16.2	14.1	16.4	15.4	13.8	13.8	12.9	12.2	11	10.3	9.8	9.6	9.3	9	68
74	16.9	15.5	13.9	15.7	15.6	13.8	15.1	14.6	13.5	13	12.1	11.6	10.4	9.8	9.4	9.2	8.8	8.7	74
80	15	14.8	13.6	14	14.7	13.6	13.5	13.7	13.1	12.2	11.4	11	9.9	9.3	9	8.7	8.4	8.3	80
86	13.4	13.9	13.2	12.9	13	13.2	11.9	12.8	12.6	11.4	10.8	10.4	9.3	8.9	8.7	8.3	8	8	86
92	11.9	12.5	12.7	11.6	11.8	12.1	10.6	11.3	11.9	10.5	10.2	9.9	8.8	8.5	8.4	7.9	7.7	7.7	92
98	10.6	11.1	11.5	10.4	10.9	11	9.8	10	10.6	9.3	9.7	9.5	8.3	8.1	8.1	7.5	7.3	7.3	98
104	9.4	9.8	10.1	9.2	9.7	10	9.1	9	9.4	8.3	8.9	9	8	7.8	7.7	7.2	7.1	7	104
110	8.4	8.7	8.9	8.2	8.6	8.9	8.2	8.5	8.6	7.6	7.9	8.3	7.5	7.4	7.4	6.9	6.8	6.8	110
116	7.5	7.8	7.9	7.3	7.7	7.9	7.3	7.7	7.9	7.1	7.1	7.4	6.8	7.1	7.1	6.5	6.5	6.5	116
122	6.7	6.9		6.5	6.8	7	6.6	6.9	7.1	6.6	6.7	6.8	6	6.5	6.7	5.8	6.1	6.3	122
128	5.9	6.1		6	6.1		6.2	6.3	6.4	6	6.3	6.4	5.3	5.7	6	5.2	5.6	5.8	128
134				5.7	5.7		5.8	5.9	5.9	5.4	5.6	5.9	4.7	5	5.3	4.5	4.9	5.2	134
140				5.5	5.6		5.2	5.4		4.8	5	5.2	4.1	4.4	4.6	4	4.3	4.5	140
146							4.7	4.8		4.3	4.5	4.6	3.6	3.9	4	3.4	3.8	4	146
152							4.2			3.7	3.9		3	3.3	3.5	3	3.2	3.4	152
158										3.2	3.4		2.5	2.8		2.5	2.7	2.9	158
164										2.8	2.9		2.1	2.3		2	2.2	2.3	164
170													1.7	1.8		1.6	1.8		170
176														1.4					176

Weitere Informationen unter www.TDKv.com

Tabellenbücher - Kranprospekte - Traglasttabellen



107-164 ft



62 ft



46,300 lbs



28'1"x23'



360°



85

85%

hydraulic jib

ft	107			119			130			142			154			164			ft
	0°	20°	40°	0°	20°	40°	0°	20°	40°	0°	20°	40°	0°	20°	40°	0°	20°	40°	
29	8.5																		29
32	8.5																		32
35	8.5			8.3															35
38	8.5			8.3			8.3												38
44	8.5			8.3			8.3			7.8									44
50	8.3	7		8.1	7		8.2			7.8			6.8			6.1			50
56	8.1	7		8	6.9		8.1	7		7.7	6.8		6.8			6.1			56
62	7.9	6.9	5.8	7.8	6.8		8	6.9		7.7	6.8		6.8	6.3		6.1	5.8		62
68	7.6	6.7	5.8	7.6	6.6	5.6	7.8	6.7	5.6	7.5	6.7		6.8	6.3		6.1	5.8		68
74	7.4	6.5	5.7	7.4	6.5	5.6	7.5	6.6	5.6	7.4	6.5	5.6	6.8	6.2	5.3	6.1	5.8		74
80	7.1	6.3	5.6	7.2	6.3	5.6	7.3	6.4	5.6	7.2	6.3	5.6	6.7	6	5.3	6.1	5.8	5.1	80
86	6.8	6.1	5.5	6.9	6.1	5.5	7.2	6.2	5.6	7	6.2	5.5	6.6	5.9	5.3	6	5.7	5.1	86
92	6.6	6	5.4	6.6	6	5.4	7	6.1	5.5	6.9	6	5.4	6.5	5.8	5.3	5.9	5.6	5.1	92
98	6.2	5.8	5.4	6.4	5.8	5.4	6.8	6	5.4	6.7	5.9	5.3	6.3	5.7	5.2	5.8	5.5	5.1	98
104	5.9	5.7	5.3	6.1	5.7	5.3	6.6	5.8	5.3	6.6	5.8	5.3	6.2	5.6	5.2	5.7	5.4	5.1	104
110	5.6	5.4	5.3	5.8	5.5	5.3	6.4	5.7	5.3	6.4	5.7	5.3	6	5.5	5.1	5.5	5.2	5.1	110
116	5.3	5.2	5.2	5.5	5.3	5.2	6.3	5.6	5.3	6.2	5.6	5.2	5.8	5.4	5.1	5.3	5.1	5	116
122	5	5	5	5.3	5.1	5.1	6.1	5.5	5.2	6.1	5.5	5.2	5.6	5.3	5.1	5.1	4.9	4.9	122
128	4.7	4.7	4.8	5	4.9	4.9	5.9	5.4	5.2	5.6	5.4	5.2	5.4	5.1	5	4.9	4.8	4.7	128
134	4.5	4.5	4.6	4.8	4.7	4.8	5.6	5.4	5.2	5.1	5.3	5.2	5	5	4.9	4.6	4.6	4.6	134
140	4.2	4.3	4.4	4.5	4.5	4.6	5.1	5.3	5.2	4.9	5.1	5.1	4.5	4.8	4.8	4.3	4.5	4.5	140
146	4	4.1	4.2	4.3	4.3	4.5	4.7	5.1	5.2	4.6	4.6	5	4	4.6	4.7	3.7	4.3	4.4	146
152	3.8	3.9		4.1	4.2	4.3	4.3	4.6	4.8	4.2	4.5	4.5	3.5	4.1	4.5	3.3	3.9	4.2	152
158				4	4		4.1	4.2	4.3	3.8	4.2	4.4	3.1	3.6	4	2.8	3.4	3.9	158
164				3.8	3.8		3.8	4	4.2	3.3	3.7	3.9	2.6	3.1	3.5	2.4	3	3.4	164
170				3.7	3.8		3.4	3.6	3.6	2.9	3.3	3.4	2.2	2.7	3	2	2.5	2.9	170
176							3	3.1		2.5	2.8	2.9	1.8	2.3	2.5	1.7	2.1	2.4	176
182							2.6			2.1	2.4		1.5	1.8	2		1.7	2	182
188										1.8	1.9			1.4	1.5			1.5	188
194										1.5									194

Weitere Informationen unter www.TDKv.com

Tabellenbücher - Kranprospekte - Traglasttabellen

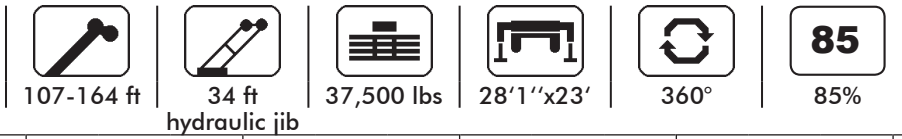

ft	107			119			130			142			154			164			ft
	0°	20°	40°	0°	20°	40°	0°	20°	40°	0°	20°	40°	0°	20°	40°	0°	20°	40°	
20	25.1																		20
23	25.1																		23
26	25.1			23.8															26
29	25.1			23.8			20.4												29
32	25.1			23.8			20.4			17									32
35	25.1	20.6		23.5			20.3			17									35
38	25.1	20.3		23.2	19.4		20.2			17			12.5			10.7			38
44	24.1	19.3	15.5	22.3	18.8	15	19.8	17.5		16.9	16		12.6			10.7			44
50	22.9	18.4	15.2	21.4	18	14.9	19.3	17.1	14.3	16.4	15.5	13.8	12.5	11.6		10.7	10.2		50
56	21.3	17.7	14.8	20.1	17.3	14.6	18.6	16.6	14.2	15.7	14.6	13.6	12.2	11.4	10.4	10.5	10	9.5	56
62	19.2	17	14.5	17.9	16.7	14.3	17.1	16.1	14	14.7	13.7	12.9	11.7	10.9	10.2	10.1	9.7	9.3	62
68	16.7	16.2	14.2	16.1	15.9	14.1	15.1	15.3	13.8	13.8	12.9	12.2	11	10.3	9.8	9.6	9.3	9	68
74	14.6	15.2	13.9	14.2	14.5	13.8	13.1	14.1	13.5	12.8	12.1	11.6	10.4	9.8	9.4	9.2	8.8	8.7	74
80	12.8	13.6	13.4	12.4	13.3	13.3	12.1	12.3	12.9	11.3	11.4	11	9.9	9.3	9	8.7	8.4	8.3	80
86	11.3	12	12.6	10.9	11.7	12.3	10.9	10.7	11.5	9.9	10.7	10.4	9.3	8.9	8.7	8.3	8	8	86
92	9.9	10.6	11.1	9.6	10.3	10.9	9.6	10.1	10	8.8	9.4	9.9	8.8	8.5	8.4	7.9	7.7	7.7	92
98	8.7	9.2	9.6	8.5	9.1	9.5	8.5	9	9.3	8.3	8.2	8.8	7.8	8.1	8.1	7.5	7.3	7.3	98
104	7.7	8.1	8.4	7.5	8	8.4	7.7	8	8.4	7.7	7.7	7.7	6.9	7.4	7.7	6.7	7.1	7	104
110	6.8	7.2	7.4	7	7	7.3	7.3	7.2	7.4	6.9	7.3	7.4	6	6.6	7	5.8	6.4	6.7	110
116	6	6.3	6.4	6.6	6.6	6.6	6.5	6.8	6.9	6.1	6.5	6.8	5.2	5.8	6.2	5	5.6	6	116
122	5.2	5.5		6.3	6.3	6.3	5.8	6.1	6.3	5.4	5.8	6.1	4.6	5	5.4	4.4	4.9	5.2	122
128	4.5	4.7		5.8	5.9		5.2	5.5	5.6	4.8	5.1	5.3	3.9	4.3	4.7	3.7	4.2	4.5	128
134				5.1	5.3		4.6	4.8	4.9	4.2	4.5	4.7	3.4	3.7	4	3.2	3.6	3.9	134
140				4.6	4.7		4	4.2		3.6	3.9	4	2.8	3.2	3.4	2.6	3	3.3	140
146							3.4	3.6		3	3.3	3.4	2.4	2.7	2.8	2.2	2.5	2.7	146
152							3			2.5	2.7			2.1	2.3		2	2.2	152
158										2.1	2.2								158
164										1.7	1.8								164

Weitere Informationen unter www.TDKv.com

Tabellenbücher - Kranprospekte - Traglasttabellen



107-164 ft



62 ft



37,500 lbs



28'1"x23'



360°



85

85%

hydraulic jib

ft	107			119			130			142			154			164			ft
	0°	20°	40°	0°	20°	40°	0°	20°	40°	0°	20°	40°	0°	20°	40°	0°	20°	40°	
29	8.5																		29
32	8.5																		32
35	8.5			8.3															35
38	8.5			8.3			8.3												38
44	8.5			8.3			8.3			7.8									44
50	8.3	7		8.1	7		8.2			7.8			6.8			6.1			50
56	8.1	7		8	6.9		8.1	7		7.7	6.8		6.8			6.1			56
62	7.9	6.9	5.8	7.8	6.8		8	6.9		7.7	6.8		6.8	6.3		6.1	5.8		62
68	7.6	6.7	5.8	7.6	6.6	5.6	7.8	6.7	5.6	7.5	6.7		6.8	6.3		6.1	5.8		68
74	7.4	6.5	5.7	7.4	6.5	5.6	7.5	6.6	5.6	7.4	6.5	5.6	6.8	6.2	5.3	6.1	5.8		74
80	7.1	6.3	5.6	7.2	6.3	5.6	7.3	6.4	5.6	7.2	6.3	5.6	6.7	6	5.3	6.1	5.8	5.1	80
86	6.8	6.1	5.5	6.9	6.1	5.5	7.2	6.2	5.6	7	6.2	5.5	6.6	5.9	5.3	6	5.7	5.1	86
92	6.6	6	5.4	6.6	6	5.4	7	6.1	5.5	6.9	6	5.4	6.5	5.8	5.3	5.9	5.6	5.1	92
98	6.2	5.8	5.4	6.4	5.8	5.4	6.8	6	5.4	6.7	5.9	5.3	6.3	5.7	5.2	5.8	5.5	5.1	98
104	5.9	5.7	5.3	6.1	5.7	5.3	6.6	5.8	5.3	6.6	5.8	5.3	6.2	5.6	5.2	5.7	5.4	5.1	104
110	5.6	5.4	5.3	5.8	5.5	5.3	6.4	5.7	5.3	6.2	5.7	5.3	6	5.5	5.1	5.5	5.2	5.1	110
116	5.3	5.2	5.2	5.5	5.3	5.2	6.2	5.6	5.3	5.7	5.6	5.2	5.5	5.4	5.1	5.2	5.1	5	116
122	5	5	5	5.3	5.1	5.1	5.7	5.5	5.2	5.5	5.5	5.2	4.9	5.3	5.1	4.7	4.9	4.9	122
128	4.7	4.7	4.8	5	4.9	4.9	5.2	5.4	5.2	5.1	5.1	5.2	4.3	5	5	4	4.7	4.7	128
134	4.5	4.5	4.6	4.8	4.7	4.8	4.9	5.1	5.2	4.5	4.9	4.9	3.7	4.5	4.9	3.5	4.3	4.6	134
140	4.2	4.3	4.4	4.5	4.5	4.6	4.6	4.7	5	4	4.6	4.8	3.2	3.9	4.5	3	3.8	4.3	140
146	4	4.1	4.2	4.3	4.3	4.5	4.1	4.5	4.6	3.5	4.1	4.5	2.7	3.4	3.9	2.5	3.2	3.8	146
152	3.8	3.9		4.1	4.2	4.3	3.6	4.1	4.3	3.1	3.6	4	2.3	2.9	3.4	2.1	2.7	3.2	152
158				3.7	4		3.1	3.5	3.7	2.7	3.1	3.4	1.9	2.4	2.9		2.3	2.7	158
164				3.3	3.5		2.7	3	3.2	2.2	2.7	2.9	1.5	2	2.4		1.9	2.2	164
170				2.9	3		2.3	2.6	2.6	1.8	2.2	2.4		1.6	1.9			1.8	170
176							1.9	2.1		1.5	1.8	1.9							176
182							1.7				1.4								182

Weitere Informationen unter www.TDKv.com

Tabellenbücher - Kranprospekte - Traglasttabellen